

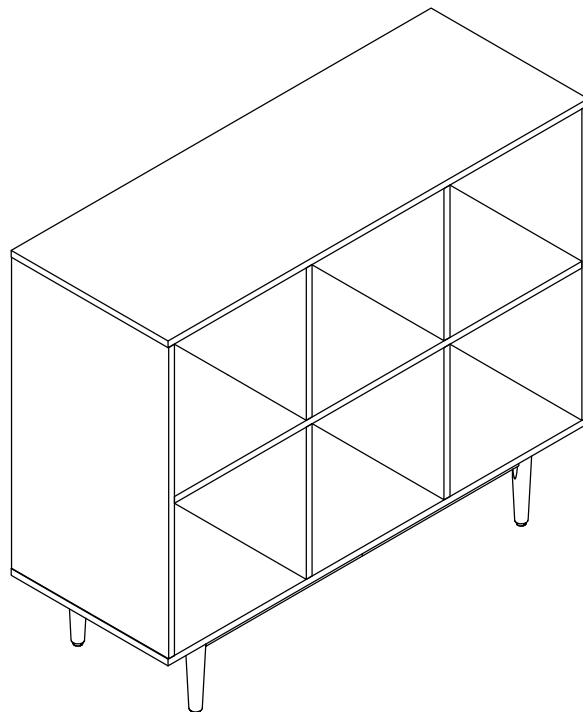

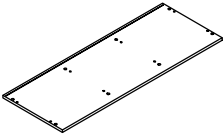

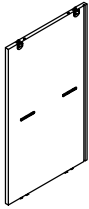

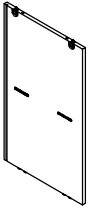

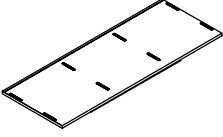
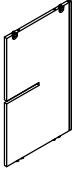
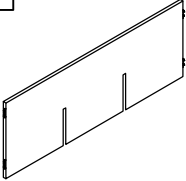
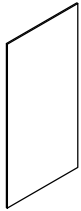



6 Cube Bookcase  
CF1121

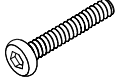

# PART LIST

<b>A</b> 	<b>B</b> 	<b>C</b> 	<b>D</b> 	<b>E</b> 
Top Panel 1 PC	Left Panel 1 PC	Right Panel 1 PC	Bottom Panel 1 PC	Partition Panel 2 PCS
<b>F</b> 	<b>G</b> 	<b>H</b> 	<b>I</b> 	
Fixed Shelf Panel 1 PC	Back Panel 2 PCS	Center Back Panel 1 PC	Leg 4 PCS	

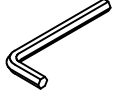
# HARDWARE LIST

<b>#1</b> 	<b>#2</b> 	<b>#3</b> 	<b>#4</b> 	<b>#5</b> 
Ø3*15mm Screw 4 PCS	Ø1/4"*1-1/2" Bolt 8 PCS (Extra 1)	Ø1/4" Flat Washer 8 PCS (Extra 1)	Ø1/4" Spring Washer 8 PCS (Extra 1)	Ø8*30mm Wood Dowel 8 PCS (Extra 1)
<b>#6</b> 	<b>#7</b> 	<b>#8</b> 		
Back Bracket 4 PCS	4mm Allen Wrench 1 PC	Safety Strap Kit 1 SET		

## ADDITIONAL TOOLS (Not Provided)

Note: It is not recommended to use power tools during assembly.

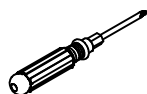

Phillips Head Screwdriver

Note: Wood dowels are intended for alignment. Additional clearance between wood dowel and pre-drilled hole is intentional for ease of assembly.

Please do not use tools to assemble this unit unless specifically indicated.

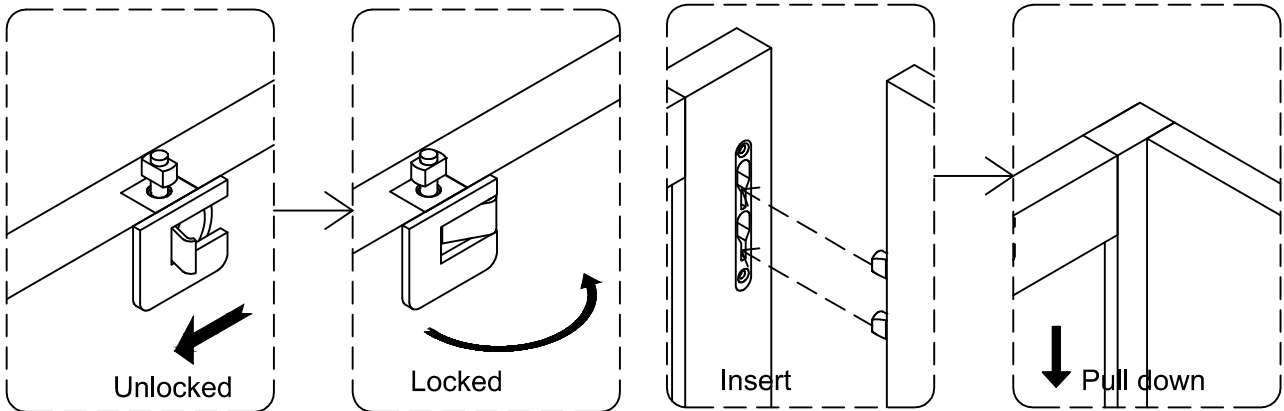

Reference the images above any time the instructions state "lock the hardware" or "insert hardware and pull down to lock".

Be sure to check all hardware is locked when complete.

Step 1. Attach legs (part I) to bottom panel (part D) using spring washers (part #4), flat washers (part #3), bolts (part #2) and allen wrench (part #7).

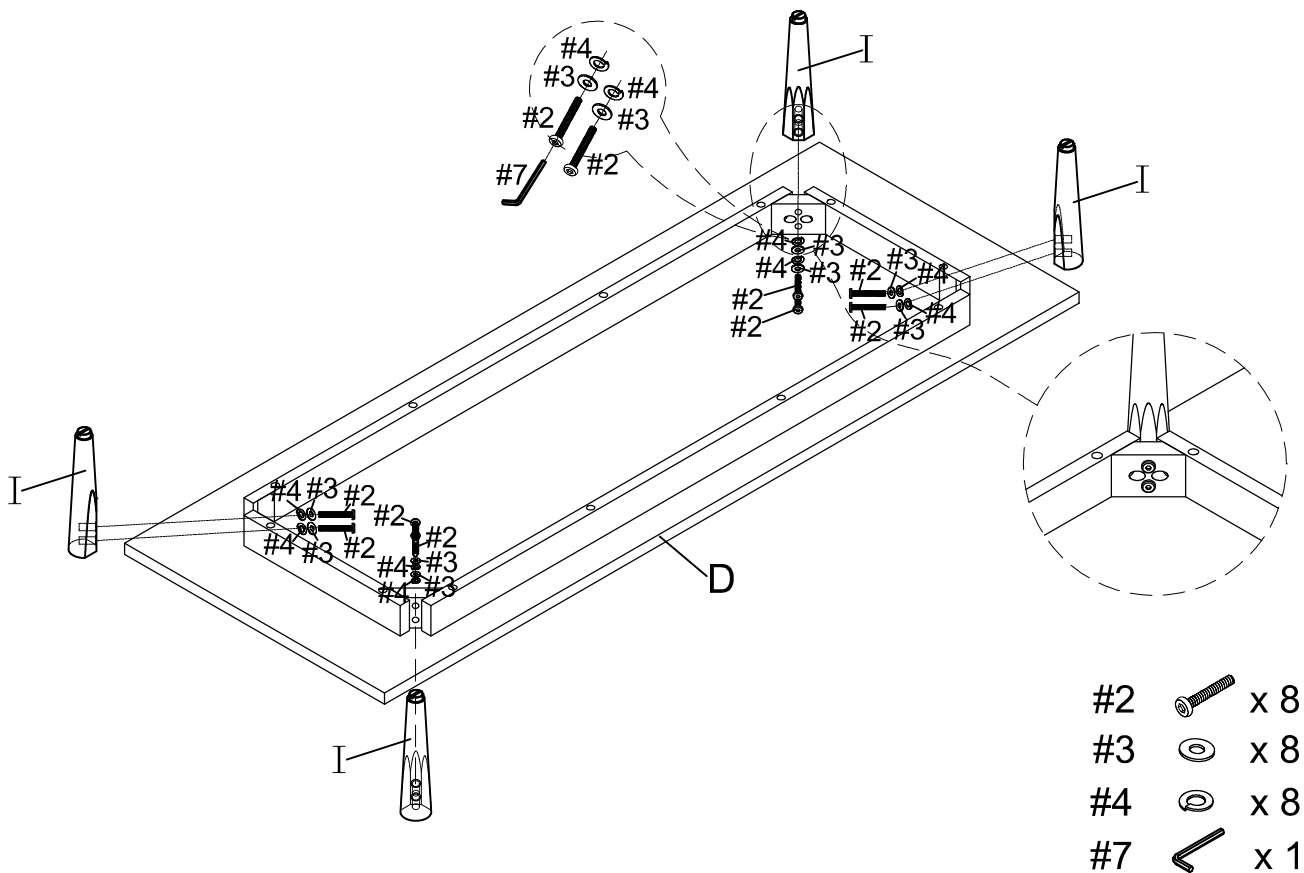

Step 2. Insert partition panels (part E) to fixed shelf panel (part F).

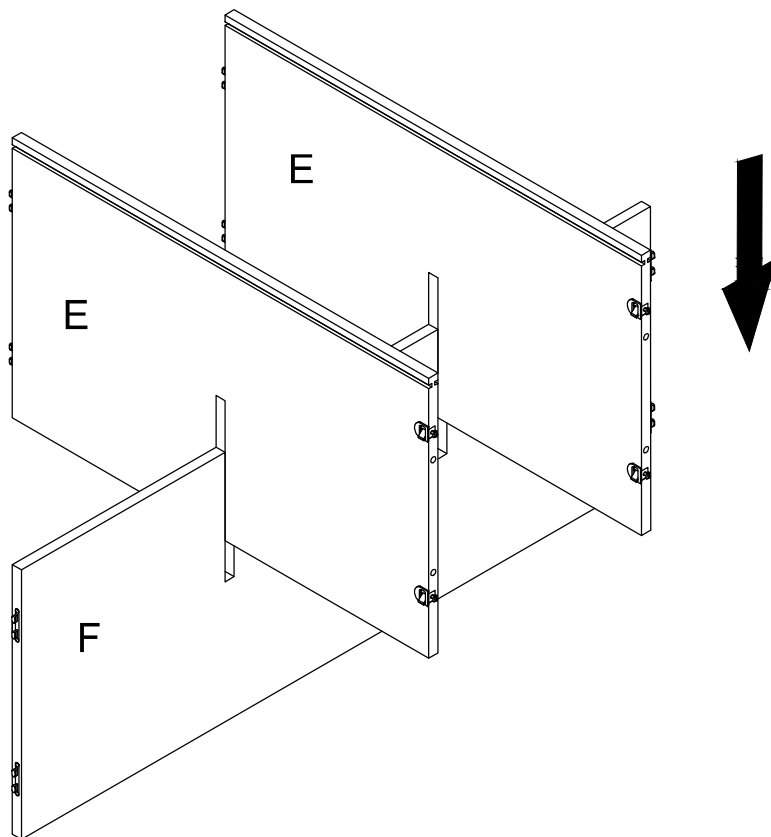

Step 3. Attach panels (parts B & C) to fixed shelf panel (part F) pull down to lock.

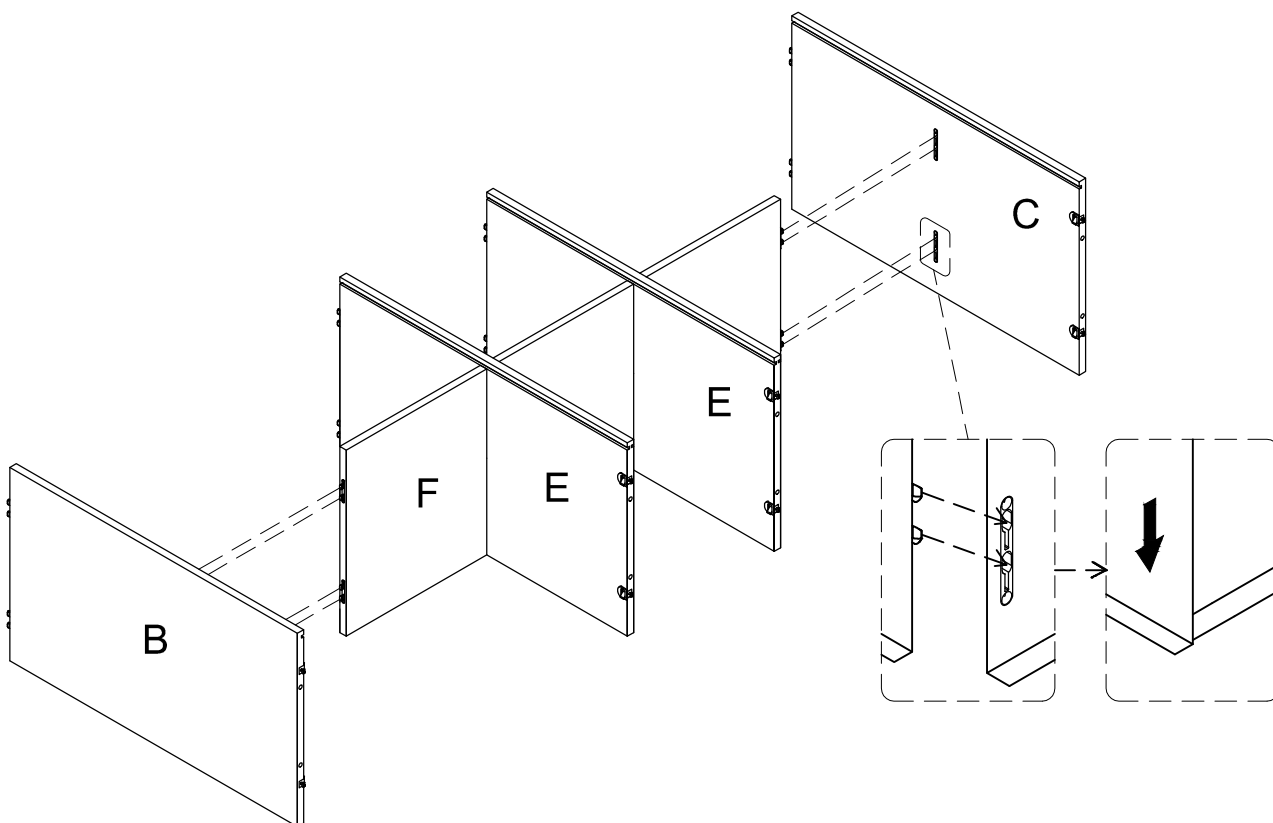

Step 4. Attach assembled unit (parts B, C & E) to bottom panel (part D) pull down to lock.

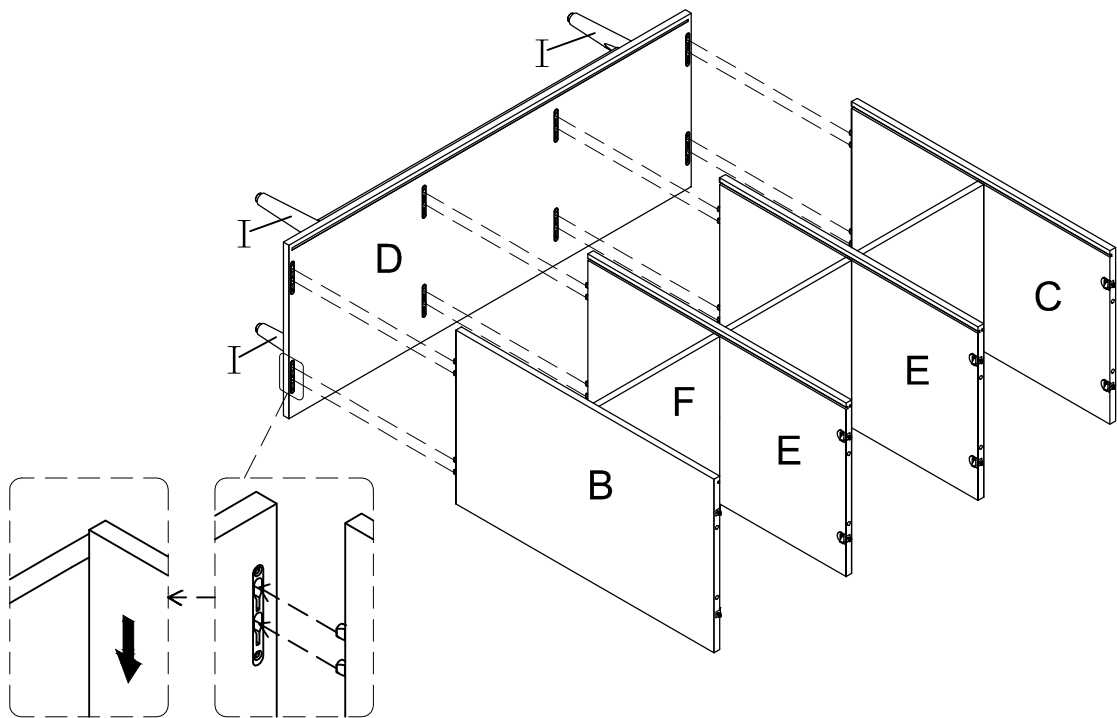

Step 5. Carefully turn unit upright. Insert back panels (parts G & H) into grooves of assembled unit (parts B, C, D & E).

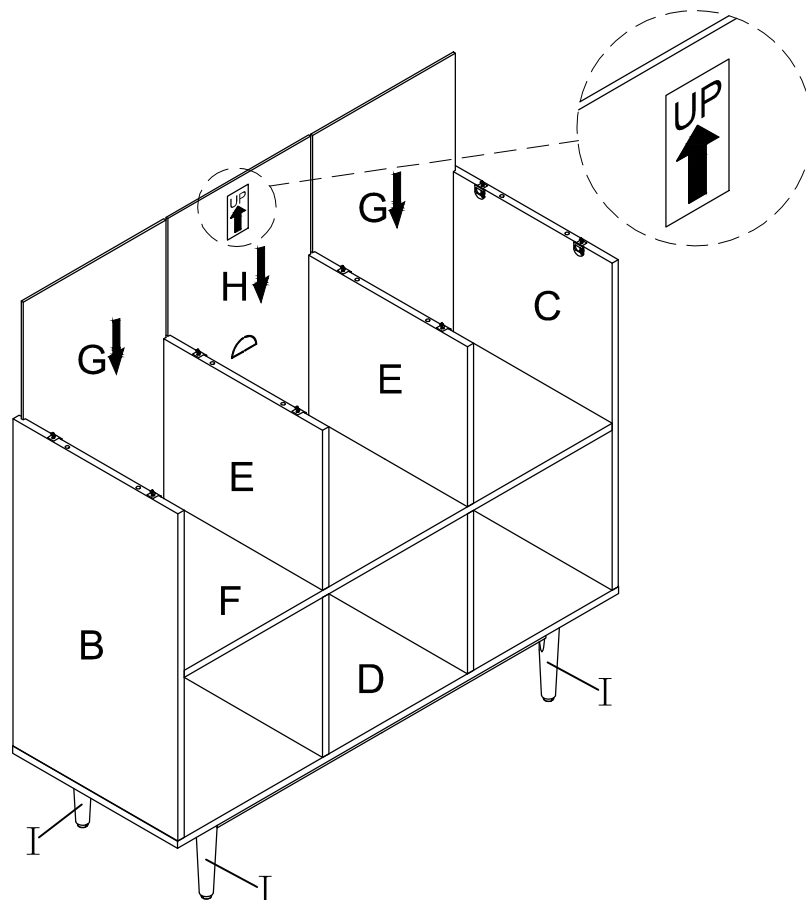

Step 6. Attach top panel (part A) to assembled unit (parts B, C & E) using wood dowels (part #5) and lock the hardware.

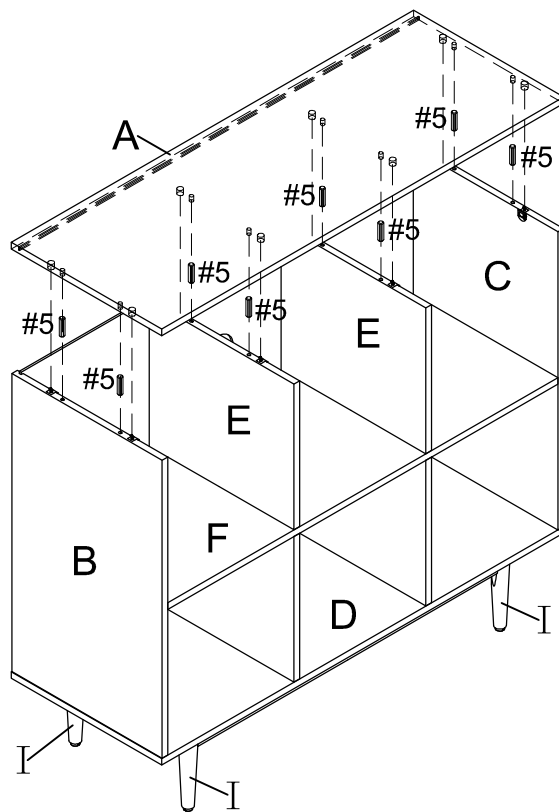

#5  x 8

Step 7. Secure back brackets (part #6) at the corner of center back panel (part H) using screws (part #1) and phillips head screwdriver.



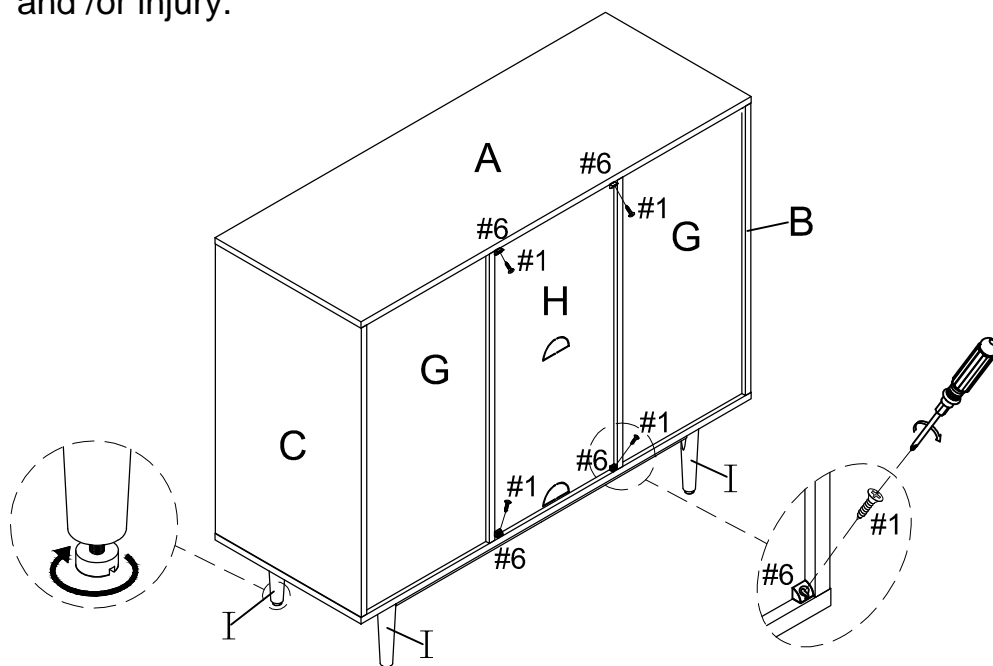

Note: It is important to adjust levelers once fully assembled and upright. Extend adjustable leveler until it's firmly in contact with the floor. If relocating, adjust leveler as needed until it's firmly in contact with the floor in new location.

Important: Safety strap kit (part #8) must be installed to preventing tipping, damage and /or injury.

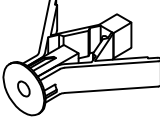

#1  x 4

#6  x 4

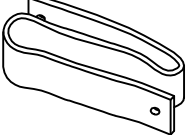
#8	A	B	C	D	E
					
Safety Strap Kit	Wall Anchor	Washer	Short Screw	Long Screw	Safety Wall Strap
1 SET	1 PC	2 PCS	1 PC	1 PC	1 PC

## SAFETY WALL STRAP INSTALLATION

Note: It is highly recommended to install this safety strap kit to prevent tipping, damage and/or injury.

1. Insert short screw (C) through washer (B) and safety wall strap (E) and attach to top panel (part A) using phillips head screwdriver.
2. Drill a 1 1/32" hole where you want to secure the unit. The drilled hole will be at the same height as the hole in top panel (part A) where the safety wall strap (E) is attached. Tap wall anchor (A) into the hole.
3. Insert long screw (D) through washer (B) and safety wall strap (E) into wall anchor (A) using phillips head screwdriver.

Note: This item is not intended for clothing storage use.

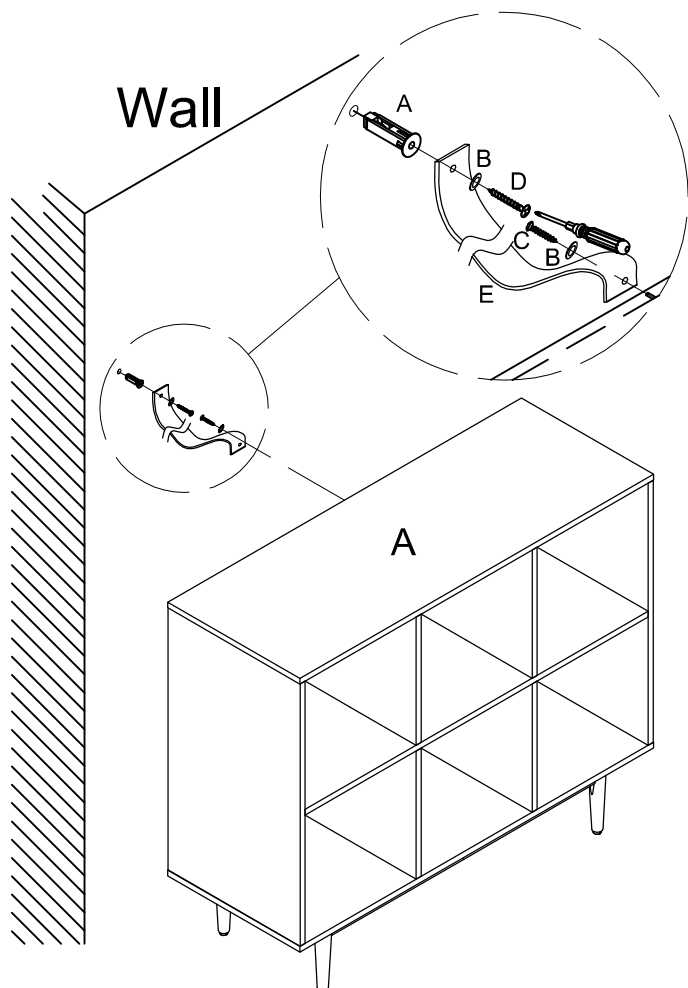

⚠ WARNING	
	<p>Children have died from furniture tipover. To reduce the risk of furniture tipover:</p> <ul style="list-style-type: none"> <li>• ALWAYS install tipover restraint provided.</li> <li>• NEVER put a TV on this product.</li> <li>• NEVER allow children to stand, climb or hang on drawers, doors, or shelves.</li> <li>• NEVER open more than one drawer at a time.</li> <li>• Place heaviest items in the lowest drawers.</li> </ul>
	<p><i>This is a permanent label. Do not remove!</i></p>